

LOW-LOSS CONNECTION OF HYBRID FIBRE OPTIC SYSTEMS WITH LOW SENSITIVITY TO WAVELENGTH

Krzysztof Skorupski

Marie Curie-Skłodowska University, Faculty of Chemistry, Laboratory of Optical Fibers Technology, Skłodowska Sq. 3, 20-031 Lublin, Poland (✉ skorupski@umcs.pl)

Abstract

This paper proposes a method for adjusting light waves propagating in systems composed of photonic fibers, light sources and detection elements. The paper presents the properties of these connections in terms of the loss of signal transmission. Different fiber core areas were analyzed, and measurements of the mode-field diameters (MFDs) of selected fiber structures are presented. The study analyzed two types of LMA (Large Mode Area) fiber structures, and the mode-field diameters of these structures were measured on the basis of the radiation distribution obtained under near-field conditions. The results are compared to the values obtained for a SMF-28 single-mode fiber. The LMA structures analyzed in the paper are characterized by low sensitivity of the MFD parameter to the length of transmitted waves, which creates the possibility of their use as intermediate fibers when connecting optical fibers of different diameters. In the wavelength range from 800 nm to 1600 nm, a 3.5% MFD change was observed for the first investigated LMA structure, and a 1% change was observed for the second. In addition, measurements of the mode-field diameters were also made using the transverse offset method for comparison of the results.

Keywords: photonic-crystal fiber, measurement of mode-field diameter, fiber characterization, beam combining.

© 2013 Polish Academy of Sciences. All rights reserved

1. Introduction

Measurements concerning the properties of light propagating in optical fibers have been performed for many years. These studies relate to the areas of light scattering [1], optical fibers and their applications [2-3], and many others. In many applications, it is important to analyze both the numerical [4] and the experimental aspects [5] of light propagation in fibers placed in a polymer composite [6] or fibers glued in special constructions [7].

Since the appearance of the first photonic-crystal fibers, in the past decade, there has been considerable development of this type of fiber-optic technology. In particular, there has been rapid development in the field of fibers produced for special applications other than telecommunications. A number of structures for sensing applications [8] and supercontinuum generation have been created.

For many photonic-crystal fibers, the size of the mode-field area is much smaller than for conventional single-mode fibers. This raises the problem of combining fiber systems that contain both types of fiber. This paper presents a method of solving this problem. The obtained results show the possibility of adjusting light waves propagating in systems composed of photonic fibers, light sources and detection elements. The article presents the properties of these connections in terms of the loss of signal transmission. Moreover, measurements of the mode-field diameters (MFDs) of selected fiber structures were performed and different fiber core areas were analyzed.

Most designed photonic-crystal fibers have smaller core surfaces than do classical single-mode fibers. This is because of the use of small values of the photonic structure pitch Λ , on the order of several micrometers [9]. In most photonic-crystal fibers, the core is implemented

as a single defect in a triangular or rectangular grid. It is formed by the removal of one of the holes and its replacement with doped or undoped glass. The use of such geometric parameters is a compromise between the transmission parameters of the fiber and the desired structural properties required for its specific applications. In addition, a very important element in optical-fiber metrology is the mathematical modeling of spectra and empirical considerations [10-12].

In conventional single-mode-fiber technology, the core diameter is determined mainly by the mode quantity. The fundamental mode propagation condition in the fiber is determined by the following relationship:

$$0 < \frac{\pi d NA}{\lambda} < 2.405. \quad (1)$$

Thus, the mode quantity in the fiber depends on the core diameter d and the numerical aperture (NA). The numerical aperture of single-mode fibers for telecommunications is usually approximately 0.14. The refractive index contrast between the cladding and the core is obtained by doping with germanium oxide at a level of approximately 3 mol%. A higher degree of dopant increases the attenuation, which is unacceptable in the case of telecommunication fibers. The dopant degree and the cutoff wavelength (approximately 1200 nm for telecommunication fibers used in the second and third transmission windows) determines the diameter of the core of such fibers to a level of approximately 10 microns.

In systems that use special photonic-crystal fibers, such fibers are used in short lengths. The primary reasons for this are the price of these optical fibers and their relatively high attenuation. Therefore, the use of supply optical fiber to connect the photonic-crystal fibers to the light sources and detection elements is often necessary. Upon the connection of classical and photonic-crystal fibers, large transmission losses arise because of the large core-area ratio and, therefore, the mode-field difference. The use of supply fibers is therefore beneficial because they are better matched to photonic-crystal fibers than are traditional telecommunication fibers. One way to obtain a low-loss connection to photonic-crystal fibers is the use of conventional fibers with a lower core diameter than that of the telecommunication fiber. In this type of fiber, a high level (several mole percent) of GeO_2 doping is applied. Side-hole fiber is an example of such a fiber. It is designed for the construction of pressure sensors [2]. Figure 1 shows an SEM (scanning electron microscope) image of this type of fiber. In this case, the core diameter of the fiber is $d = 3.8 \mu\text{m}$ and the cut-off wavelength is $\lambda_c = 1500 \text{ nm}$.

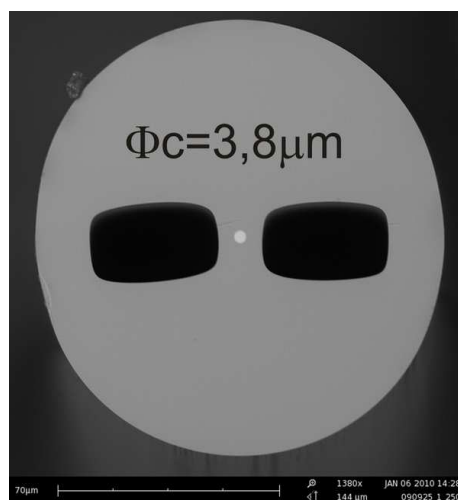

Fig. 1. An image of a side-hole fiber obtained with a scanning electron microscope.

A high dopant level allows the preparation of a waveguide with a cut-off wavelength located close to the second or third transmission window, while the core diameter is maintained on the order of 4 microns. The use of an increased amount of GeO₂ dopant increases the attenuation value to several decibels per kilometer.

Another way to obtain low-loss connections is the use of LMA (Large Mode Area) photonic-crystal fibers. This type of fiber is an attractive alternative to conventional fibers for signal transmission over short distances [13-14]. Figure 2 shows a SEM image of an LMA fiber.

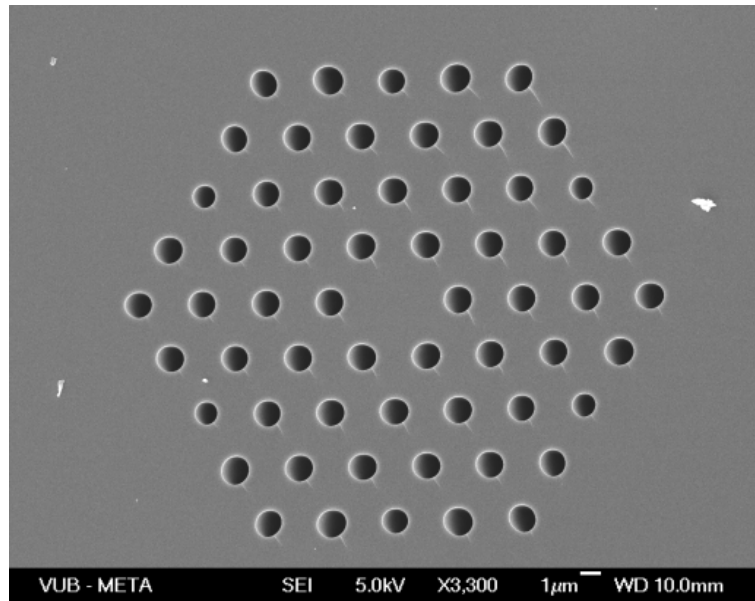

Fig. 2. An image of a large-mode-area photonic-crystal fiber obtained with a scanning electron microscope.

This type of fiber is commercially available, as are patch cords constructed from these fibers. Fibers with mode-field diameters of 5 microns to 25 microns are also available, in addition to polarization-maintaining LMA fibers with core diameters of 5 microns to 15 microns. The grid of these fibers is triangular with a lattice constant of 3.5 microns, in which the core is implemented as a defect resulting from the elimination of one or more large holes in the middle of the structure. The minimal attenuation of these fibers is 2 dB/km. A characteristic feature of this type of fiber is a slight change in the mode-field diameter as a function of wavelength [15].

2. Measurements of the mode-field diameters of selected fiber structures

To determine the effectiveness of optical-fiber connections, it is necessary to determine the MFD parameter of the combined fibers. For the MFD measurement, the transverse offset method [16-17] was used. The measurement system was constructed in the configuration shown in Figure 3 and was able to carry out measurements in a wavelength range from 450 nm to 2000 nm with a spectral resolution of 5 nm. The resolution of the MFD measurement was equal to 0.2 microns, which was determined by the accuracy of the utilized micro-mechanical elements.

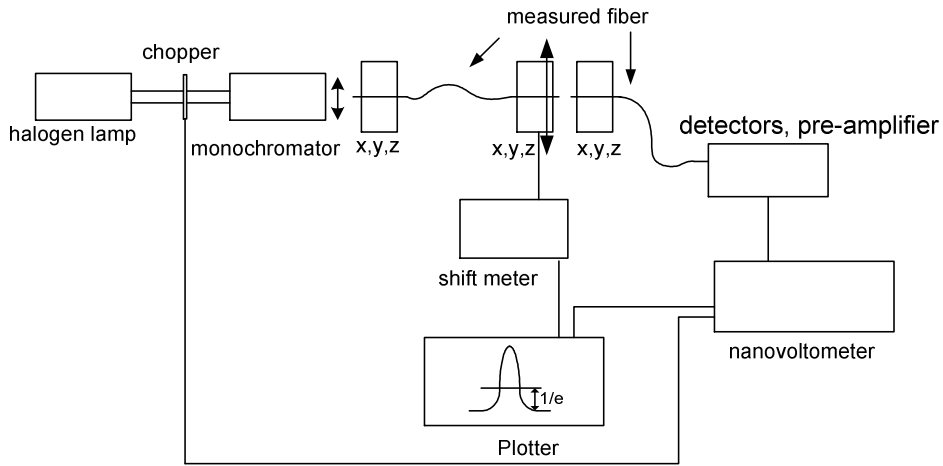

Fig. 3. The diagram of the system used for MFD measurement via the transverse offset method.

The presented method involves the transverse motion of the fiber divided into two sections. The optical fiber is stimulated by monochromatic light of the desired wavelength (820nm) from the superluminescent diode and SM 820 supply fibers. This results in lateral displacement of one end of the fiber. The registered light power is thus a function of the lateral shift of the fiber end. The measurement performed in the present system did not allow control of the measured fiber rotation. Therefore, it did not allow the selection of a particular axis of symmetry of the photonic-crystal fiber's structure for the measurement.

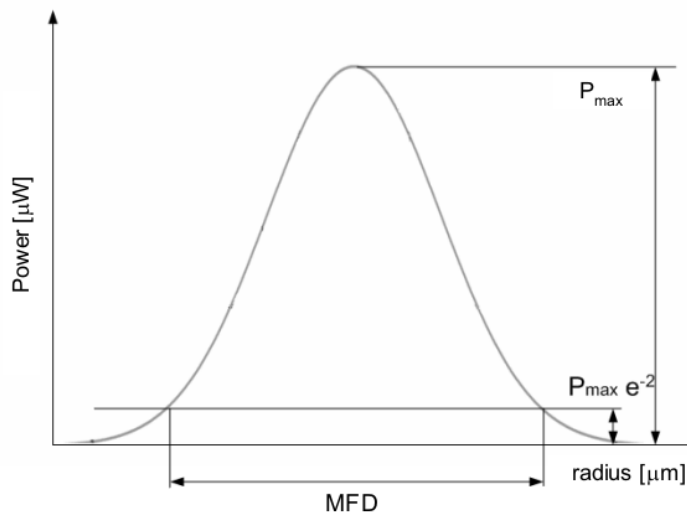

Fig. 4. The radiation distribution under far-field conditions and the MFD determination method.

As shown in Figure 4, the mode-field diameter was defined by determining the width of the measured radiation distribution at a power level corresponding to the P_{\max}/e^2 level (Fig. 4).

In many applications, a camera system and a laser beam are required for image acquisition and processing methods. In the case of the MFD measurement it is possible to use the method for a single wavelength by measuring the near-field distribution [18]. To determine the change of the MFD according to the symmetry axis of the photonic-crystal structure, the measurement was performed for the two symmetry axes of the fiber. Figure 5 shows a diagram of the measuring system that was used for this task.

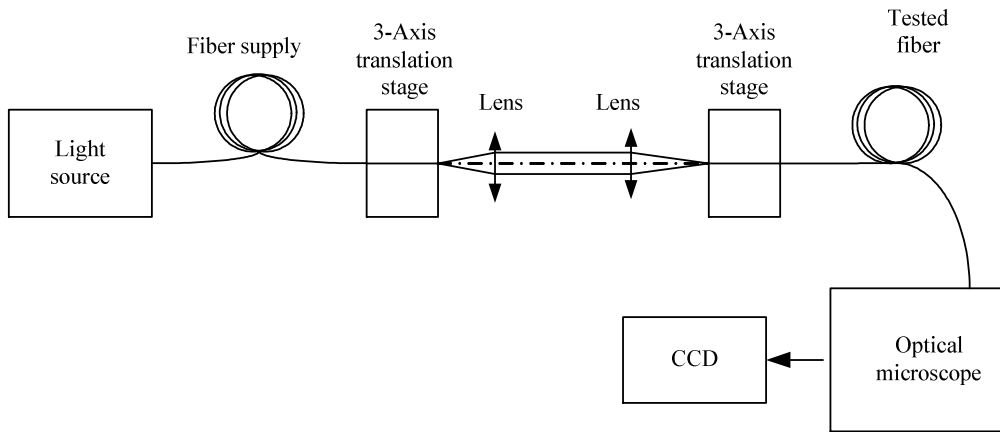

Fig. 5. The diagram of the system used for MFD measurement via the near-field method.

Figure 6 presents the resulting near-field images; the radiation distributions (Fig. 7) were determined on the basis of the marked lines. The mode field of the presented LMA fiber is a regular hexagon. It is associated with the layout of photonic structure holes, which are distributed in a triangular lattice. The mode field diameter is defined along the symmetry axis of the photonic structure.

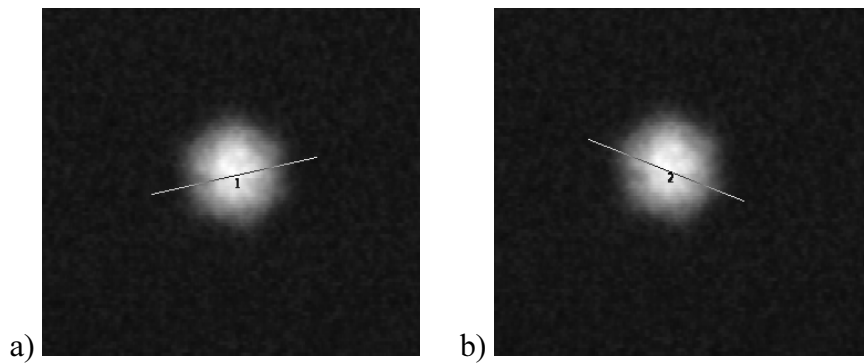

Fig. 6. Near-field images taken using the proposed measurement system: a) the method of determining the minimum diameter and b) the method of determining the maximum diameter.

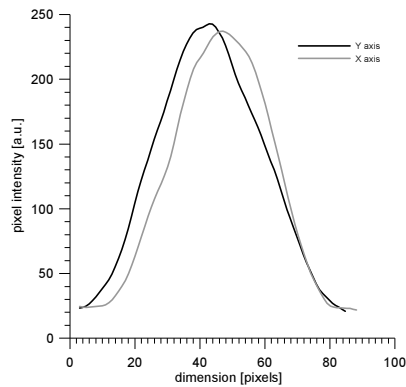

Fig. 7. Determined radiation distributions for both axes of symmetry.

The measurements were performed for the conventional single-mode fiber SMF-28 and for two LMA photonic-crystal fibers [19]. Table 1 shows the geometric parameters of the fibers: the output diameter ϕ , the pitch Λ and the hole diameter d .

Table 1. The geometric parameters of the measured LMA fibers.

Fiber type	ϕ [μm]	d [μm]	Λ [μm]
LMA1	130	3.2	7
LMA2	126	1.4	4.4
SMF-28	125	-	-

Figure 8 shows SEM images of the measured fibers.

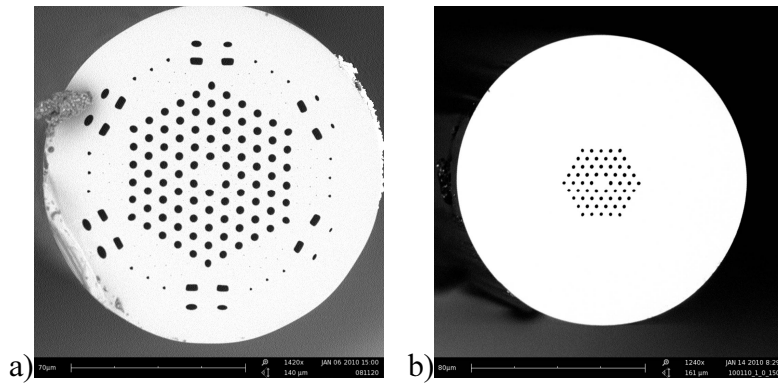

Fig. 8. SEM images of the measured LMA fibers: a) the LMA1 structure, with a higher lattice constant, and b) the LMA2 structure, with a lower lattice constant.

The measurement results are shown in Figure 9. The measurements of the SMF-28 fiber were performed for the wavelength corresponding to the single-mode propagation using the transverse offset method. For the LMA fibers, the measurements were performed using the transverse offset method in a wavelength range of 800 nm to 1600 nm. Moreover, a measurement using the near-field distribution method for a wavelength of 1550 nm was also performed. The measurements of both fibers were taken for the fundamental mode.

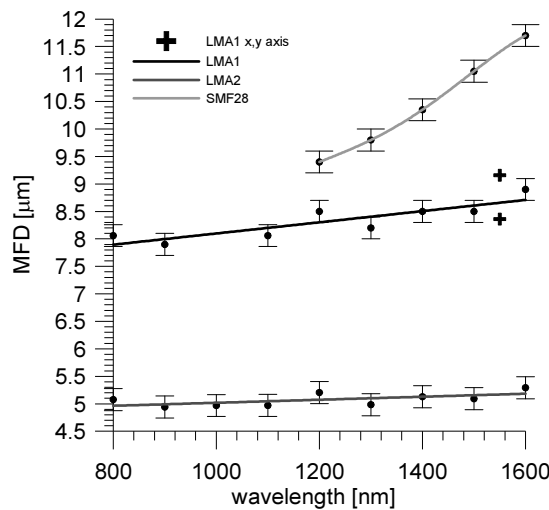

Fig. 9. A plot of the MFD as a function of wavelength for all measured fibers.

On the basis of Figure 9, it can be seen that with the increase of the wavelength from 800 nm to 1600 nm, the mode-field diameter increased by 0.84 microns and 0.21 microns for the LMA1 and LMA2 fibers, respectively. This corresponds to a change in the MFD parameter of 10% for the LMA1 structure and 4% for the LMA2 structure. For comparison, the brown line in Figure 9 represents the dependence of the MFD on the wavelength for the SMF-28 fiber. The percentage change in the MFD parameter, converted to the corresponding spectral range, for this fiber is 40%, which is an order of magnitude greater than the changes observed in the LMA structures. The average value of the MFD was 8.5 μm for the LMA1 structure and 5.2 μm for the LMA2 structure. The blue points in Figure 9 represent the values measured for the LMA1 fiber using the near-field method. These values correspond to the MFDs measured for the two symmetry axes of the photonic-crystal structure. The average of the maximum and minimum values was taken to be the MFD value for the photonic-crystal fibers [20], which was 8.8 μm for the LMA1 structure for a wavelength of 1550 nm.

3. Conclusions

A method that provides matched light-wave propagation in systems composed of hybrid fiber optics, light sources and detection elements has been proposed. In this paper, the properties of fiber-optic connections from the point of view of transmission losses have been presented. The study analyzed two types of LMA fiber structures, and the mode-field diameters of these structures were measured on the basis of the radiation distribution obtained under far-field conditions.

The measurements of the mode-field diameters for two fundamental modes of an LMA photonic-crystal fiber were compared to the values obtained for a conventional SMF-28 fiber. The results of the MFD measurements for the SMF-28 fiber show a significant increase in the mode-field diameter as a function of the wavelength of the propagated signal. The smallest value of the mode-field diameter, equal to 9.4 μm , was obtained at a wavelength of 1200 nm, which was also the cut-off wavelength. For a wavelength of 1600 nm, the MFD parameter increased to 11.5 μm . The MFD measurements for the LMA fiber confirmed a slight MFD variation as a function of wavelength. In the analyzed spectral range, the change in the MFD for the classical fiber was 22%, while in the case of the LMA1 fiber, the MFD change in the considered wavelength range was 3.5%, and for the LMA2 fiber it was only 1%. The MFD measurements performed using the near-field method yielded two results for the two symmetry axes of the photonic-crystal structure. The measurement performed using the transverse offset method yielded the expected intermediate result for the same wavelength.

The results indicate the possibility of using LMA fibers in combination with special photonic-crystal fibers to minimize connection loss. LMA fibers demonstrate significantly improved spectral properties with respect to classical fibers, which may be desirable in broadband light-source applications such as a supercontinuum or amplified spontaneous emission.

4. References

- [1] Mroccka, J., Wysoczański, D. (2000). Plane-wave and Gaussian-beam scattering on an infinite cylinder. *Optical Engineering*, 39(3), 763–770.
- [2] Wojcik, J., Urbańczyk, W., Bock, W., Janoszczuk, B., Mergo, P., Makara, M., Poturaj, K., Spytek, W. (1999). Prototype of the side-hole HB optical fiber. *Proceedings SPIE*, 3731.
- [3] Hotra, Z., Mykytyuk, Z., Sushynskyy, O., Hotra, O., Yasynovska, O., Kisala, P. (2010). Sensor systems with optical channel of information transferring. *Electrotechnical Review*, 86(10), 21–23.

- [4] Girasole, T., Bultynck, H., Gouesbet, G., Gréhan, G., Le Meur, F., Le Toulouzan, J.N., Mroczka, J., Ren, K.F., Rozé, C., Wysoczanski, D. (1997). Cylindrical fibre orientation analysis by light scattering. Part 1: Numerical aspects. *Particle and Particle Systems Characterization*, 14(4), 163–174.
- [5] Girasole, T., Gouesbet, G., Gréhan, G., Le Toulouzan, J.N., Mroczka, J., Ren, K.F., Wysoczanski, D. (1997). Cylindrical fibre orientation analysis by light scattering. Part 2: Experimental aspects. *Particle and Particle Systems Characterization*, 14(5), 211–218.
- [6] Girasole, T. Le Toulouzan, J. N., Mroczka, J., Wysoczanski, D. (1997). Fiber orientation and concentration analysis by light scattering: Experimental setup and diagnosis. *Review of Scientific Instruments*, 68(7), 2805–2811.
- [7] Kisała, P. (2013). Measurement of the maximum value of non-uniform strain using a temperature-insensitive fibre Bragg grating method. *Opto-electronics Review*, (21)3, 293–302.
- [8] Kisała, P. (2012). Application of inverse analysis to determine the strain distribution with optoelectronic method insensitive to temperature changes. *Applied Optics*, 51(16), 3599–3604.
- [9] Knight, J. C. (2003). Photonic crystal fibres. *Nature*, 424, 847-851.
- [10] Czerwiński, M., Mroczka, J., Girasole, T., Gouesbet, G., Grehan, G. (2001). Light-Transmittance Predictions Under Multiple-Light-Scattering Conditions. I. Direct Problem: hybrid-Method Approximation. *Applied Optics*, 40(9), 1514–1524.
- [11] Czerwiński, M., Mroczka, J., Girasole, T., Gouesbet, G., Grehan, G.(2001). Light-Transmittance Predictions Under Multiple-Light-Scattering Conditions. II. Inverse Problem: Particle Size Determination. *Applied Optics*, 40(9), 1525–1531.
- [12] Mroczka, J. (2013). The cognitive process in metrology. *Measurement*, 46, 2896–2907.
- [13] Knight, J. C. (1998). Large mode area photonic crystal fibre. *Electron. Lett.*, 34, 1347.
- [14] Folkenberg, J.R., Nielsen, M.D., Mortensen, N.A., Jakobsen, C., Simonsen, H.R. (2004). Polarization maintaining large mode area photonic crystal fiber. *Optics Express*, 12(5), 956–960.
- [15] Nielsen, M.D., Folkenberg, J.R., Mortensen, N.A., Bjarklev, A. (2004). Bandwidth comparison of photonic crystal fibers and conventional single-mode fibers. *Optics Express*, (12)3, 430–435.
- [16] Young, M. (1998). Mode-Field Diameter of Single-Mode Optical Fiber by Far-Field Scanning. *Applied Optics*, 37(36), 8361–8361.
- [17] Billington, R. (1999). Effective Area of Optical Fibres Definition and Measurement Techniques. *Centre for Optical and Environmental Metrology*.
- [18] Miyagi, K., Namihira, Y., Razzak, S., Kaijage, S., Begum, F. (2010). Effective Area of Optical Fibers- Definition and Measurement Techniques. *Optical Review*, 17(4), 388–392.
- [19] Koshiba, M. Saitoh, K. (2003). Structural dependence of effective area and mode field diameter for holey fibers. *Optics Express*, 11(15), 1746–1756.
- [20] Nakamura, A., Ohashi, M. (2010). Definition of MFD of photonic crystal fibers. *Communications and Photonics Conference and Exhibition (ACP)*.